

General Characteristics

The HYMANN HY-RC products are mechanisms that joint hoses resisting the pressure exerted by the fluid.

Technical Specifications

Thread	M36x2
Nominal pressure	1000 bar
Maximal pressure	1600 bar
External dimensions	Length: 39 mm - \varnothing : 54 mm

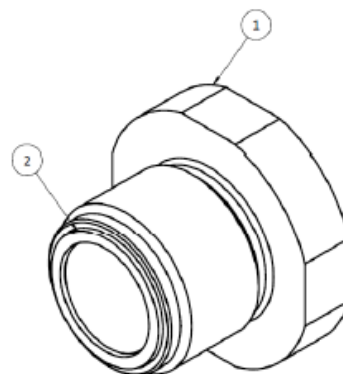

Material

Body	Alloy Steel
Surface treatment	Chromium
Seal	Copper Alloy

